

# Standard Endoscopic Camera System Manual



**HAYDEN MEDICAL**

Hayden Medical | [info@haydenmedical.com](mailto:info@haydenmedical.com) | 661-296-7200

## Contents

CHAPTER 1 – FUNCTION DESCRIPTION .....	3
1.1 BUTTON INTERFACE FUNCTION DESCRIPTION .....	3
1.2 SCREEN BUTTON FUNCTION .....	4
CHAPTER 2 – INSTALLATION .....	4
2.1 Installation Procedure .....	4
2.1.1 Installation Reference 1 .....	5
2.1.2 Installation Reference 2 .....	5
CHAPTER 3 – VIDEO RECORDING .....	6
CHAPTER 4 – MONITOR PARAMETER .....	7
CHAPTER 5 – INSTRUCTIONS FOR USE .....	8
5.1 Camera System Operation .....	8
5.2 Accessories – Requirements and Use .....	8
CHAPTER 6 – WARNINGS, PRECAUTIONS, AND SAFETY NOTES .....	9
6.1 General Safety .....	9
6.2 Cleaning and Handling .....	9
6.3 Operation and Storage .....	9
6.4 Burn and Optical Hazard Warnings .....	9
6.5 Transport and Packaging .....	10
6.6 Maintenance and Service .....	10
6.7 Thermal and Physical Safety .....	10
6.8 Electromagnetic Compatibility (EMC) .....	10
6.9 System Compatibility and Use .....	10
6.10 Operational Safety and Backup Planning .....	10
CHAPTER 7 – TROUBLESHOOTING .....	11
7.1 System Check .....	11
7.2 Troubleshooting Guide .....	12
CHAPTER 8 – CARE AND MAINTENANCE .....	13
8.1 Environmental Requirements .....	13
8.2 Equipment Care and Handling .....	13
8.3 Transportation and Storage .....	14

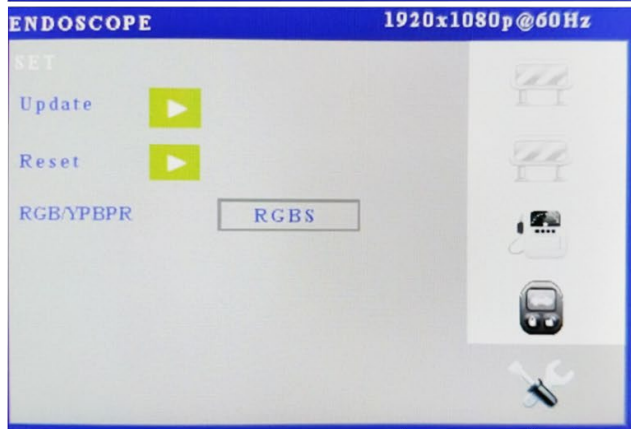
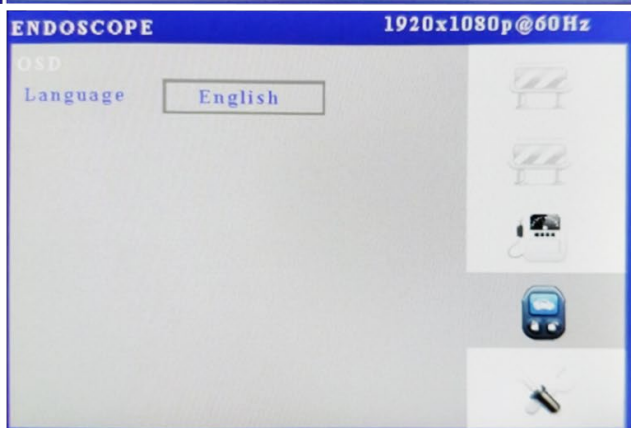
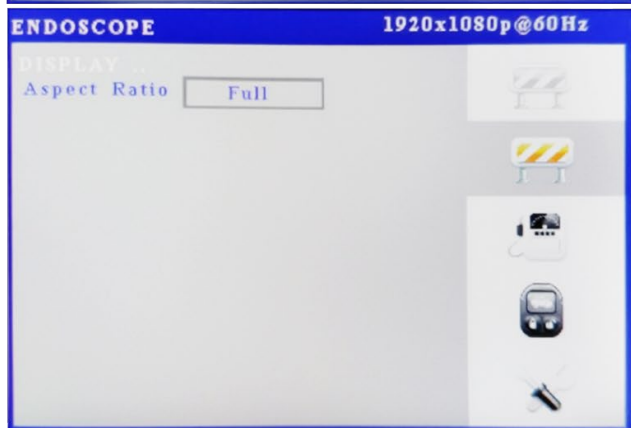
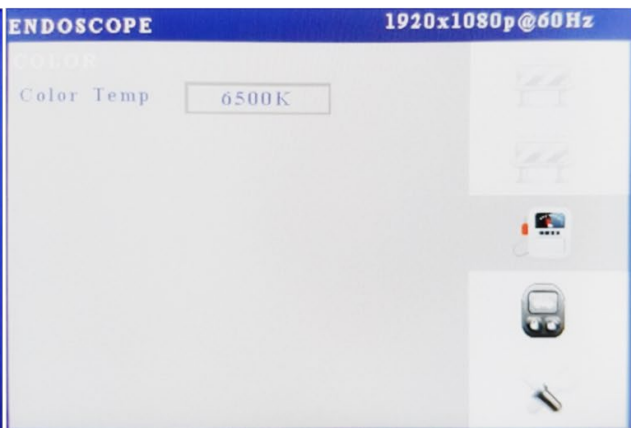
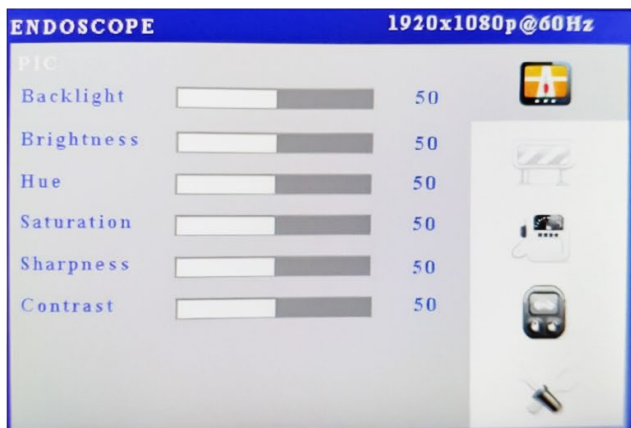

## Chapter 1 – Function Description

### 1.1 Button Interface Function Description

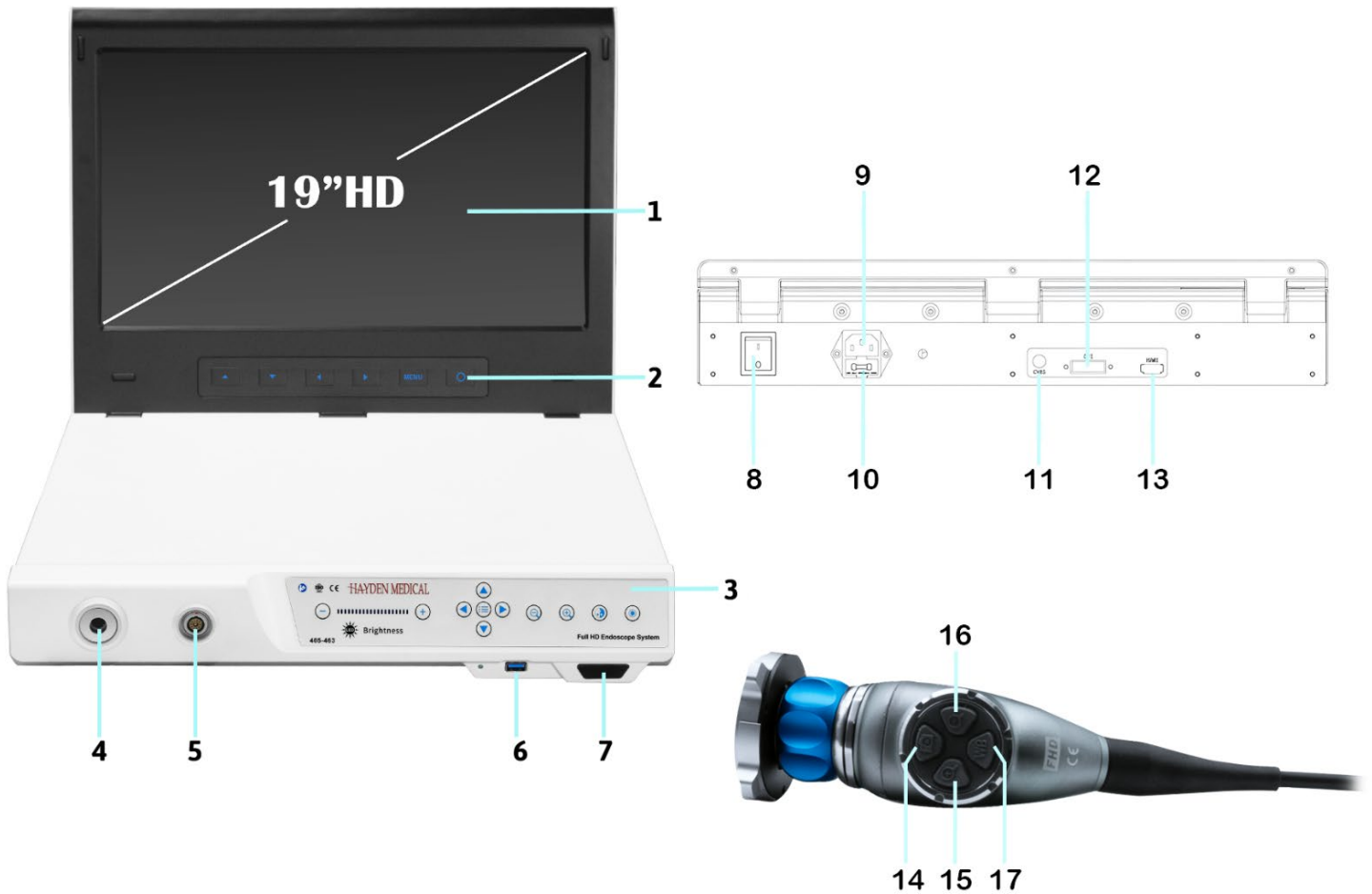

1. 19-inch HD medical monitor
2. Screen operation panel
3. Camera operation panel
4. LED light interface
5. Camera interface
6. USB interface
7. Power switch
8. Power supply switch
9. Power outlet (AC 110V-220V)

10. Fuse
11. CVBS
12. DVI
13. HDMI
14. Image capture
15. Zoom in
16. Zoom out
17. White balance

## 1.2 Screen Button Function

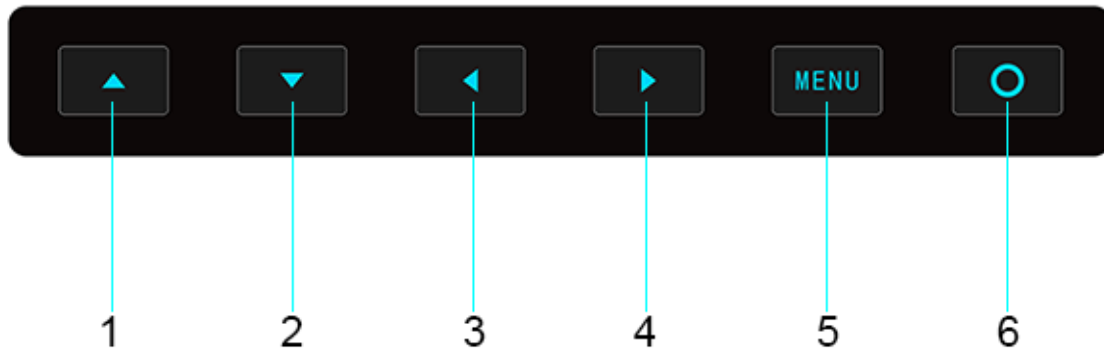

- |                      |   |
|----------------------|---|
| 1. Up                | 4. Right (adjust monitor color pattern) |
| 2. Down              | 5. Menu / Confirmation                  |
| 3. Left (not in use) | 6. Return                               |

## Chapter 2 – Installation

### 2.1 Installation Procedure

1. After unpacking, verify all components against the packing list. Ensure the main unit and all accessories are present and undamaged. Read this instruction manual thoroughly before installation.
2. Connect the camera head and optical coupler to the appropriate ports on the camera control cable. Ensure all connections are secure.
3. Connect one end of the fiber optic cable to the designated port and ensure it is firmly attached.
4. Connect each device (camera control unit, light source, and display) to its respective power input using the provided power cords.
5. After confirming that all connections are correct, connect the system to power outlet.
6. Turn on the power by switching the power control to position "1". Verify that the power indicator light illuminates.
7. Once the image is displayed normally, use the corresponding controls on the front panel to operate and observe the image.

### 2.1.1 Installation Reference 1

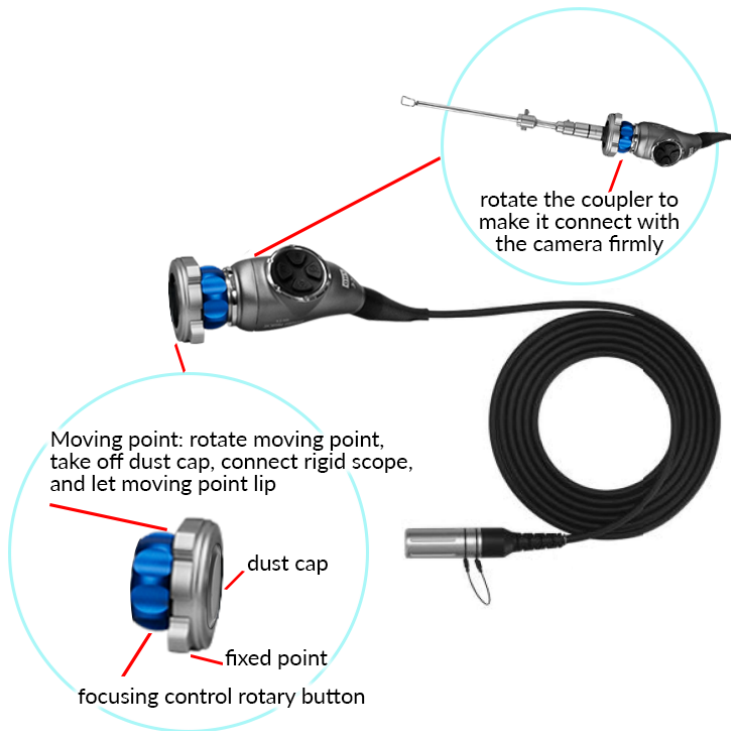



### 2.1.2 Installation Reference 2



## Chapter 3 – Video Recording



1. Insert a USB storage device into the USB port located on the front panel of the unit.
2. Press the **Record**  button to start recording.
3. The indicator light  will turn **green**, confirming that recording is in progress.
4. Press the **Record**  button again to stop recording.
5. When the indicator light flashes **three times**, the recorded video has been successfully saved to the USB storage device.
6. Remove the USB storage device and connect it to a computer to access the recorded video files.

### Chapter 4 – Monitor Parameter



## Chapter 5 – Instructions for Use

### 5.1 Camera System Operation

1. If the image is not clear, verify that the endoscope is properly connected and adjust the focal length of the optical coupler until a clear image is obtained.
2. Ensure the power plug is securely connected. The power switch must only be turned on after the device is properly plugged into a power source.
3. Place the main unit on a stable, level surface. Regularly check that all components are secure to prevent the device from falling and becoming damaged.
4. Keep the camera system away from sources of strong electromagnetic interference.
5. To disconnect the system, unplug the external power supply completely. Ensure the unit is fully powered off before covering it with a protective drape.

### 5.2 Accessories – Requirements and Use

#### 1. **Optical Coupler**

The camera is compatible with C-mount optical couplers (F14–F32).

Remove the protective cap prior to use. After cleaning, connect the camera head to one end and the optical endoscope to the other.

After use, clean and disinfect the coupler and reinstall the protective cap.

#### 2. **Fiber Optic Cable**

Connect one end to the 10 mm light source output port and the other end to the optical endoscope.

Ensure all connections are secure. Do not twist, kink, or subject the cable to heavy loads (e.g., being run over).

#### 3. **Power Cable**

Use a standard power cord. Connect one end to a ~220 V / 50 Hz power supply and the other end to the main unit of the endoscope imaging system.

#### 4. **Video Output Cables**

(DVI, HDMI, or VGA)

Connect one end to the main unit and the other end to the display device. Ensure compatibility with the selected output interface.

#### 5. **Optical Endoscope**

Compatible with various rigid optical endoscopes. Ensure that connection types match the fiber cable and optical coupler interfaces.

Remove the protective cap before use. After cleaning, connect the optical coupler and fiber cable, then adjust the focus mechanism to obtain a clear image.

After use, clean and disinfect the endoscope and reinstall the protective cap.

## Chapter 6 – Warnings, Precautions, and Safety Notes

### 6.1 General Safety

1. This equipment is intended for use only with the designated system. Use for any other purpose may result in equipment damage and void the manufacturer's warranty.
2. Do not move, shake, connect, or disconnect any components while the system is powered on.
3. The equipment must be operated in a clean, dry, and well-ventilated environment. Maintain a minimum clearance of **5 cm** around the device to ensure adequate ventilation.  
Do not place the system near or stacked with other equipment unless proper operation under such conditions has been verified.
4. Keep the equipment away from chemicals, strong electromagnetic fields, and electrical interference sources.

### 6.2 Cleaning and Handling

5. Due to static electricity, the equipment surface may attract dust. Before cleaning, disconnect the power supply. Wipe the surface with a soft, lint-free cloth to prevent scratching.
6. If dust is present on the camera head, clean it using absorbent cotton and alcohol.

### 6.3 Operation and Storage

7. Avoid frequent power cycling. Allow a minimum interval of **3 seconds** between power-off and power-on.
8. When not in use:
  - Turn off the power
  - Disconnect the external power supply
  - Cover the unit with a protective cloth

For long-term storage, clean the device, store it in its original packaging, and power it on periodically (recommended: once every two months).

### 6.4 Burn and Optical Hazard Warnings

9. The light source emits high-intensity illumination. **Do not look directly into the light output**, as this may cause eye injury.
10. The light output port may reach high temperatures during operation. Avoid contact to prevent burns.
11. After powering off the device, allow at least **2 minutes** before disconnecting the fiber optic cable to prevent burns caused by residual heat.

## 6.5 Transport and Packaging

12. The equipment is packaged in a carton or plywood case. Protect it from moisture, impact, and compression during transportation.  
The device may be transported by air, road, or rail.

## 6.6 Maintenance and Service

13. Only manufacturer-approved components may be used for replacement (e.g., fuse model **F3AL 250V**).
14. If the system malfunctions, **do not open the device housing**. Contact the manufacturer or authorized service personnel.
15. The LED light source module must only be replaced by qualified personnel using the specified model (**M106, DC12V, ≤5A**).
16. Installation, commissioning, and servicing must be performed only by trained and qualified medical technicians.

## 6.7 Thermal and Physical Safety

17. If the surface temperature of any applied part exceeds **41°C**, discontinue use and allow the device to cool before reuse to prevent burns.
18. Before use, inspect all components for damage, including rough surfaces, sharp edges, or protrusions that could pose a safety risk.

## 6.8 Electromagnetic Compatibility (EMC)

19. This equipment requires special EMC precautions. Install and operate the system in accordance with the EMC guidelines provided in this manual.
20. Portable and mobile RF communication devices may interfere with the operation of the system.
21. Use only manufacturer-specified accessories, cables, and components. Use of non-approved components may increase electromagnetic emissions or reduce system immunity.

## 6.9 System Compatibility and Use

22. The system is compatible with rigid endoscopes conforming via the objective lens adapter.  
Signal output may be connected to display devices with compatible input interfaces.
23. When used in combination with other medical electrical equipment, ensure all devices meet applicable safety standards, particularly leakage current requirements.

## 6.10 Operational Safety and Backup Planning

24. This equipment may be used in conjunction with other surgical devices. Users must be familiar with the performance, operation, and safety precautions of all associated instruments and follow established surgical protocols.
25. In the event of equipment failure, appropriate contingency measures must be in place (e.g., backup equipment or alternative procedures) to ensure patient safety.

## Chapter 7 – Troubleshooting

### 7.1 System Check

Before troubleshooting, perform the following checks:

- Verify that the power supply is functioning properly and that the main unit power cord is securely connected to the power outlet.
- Confirm that all cables and ports are properly connected and undamaged.
- **Fuse Replacement:**
  - Disconnect the power cord before servicing.
  - Use an appropriate tool to open the fuse holder on the power input filter.
  - Remove and replace the fuse with the specified type (**F3AL 250V**).
  - Ensure the fuse cap is securely closed after replacement.

## 7.2 Troubleshooting Guide

<b>Problem / Symptom</b>	<b>Possible Cause</b>	<b>Corrective Action</b>
<b>No image displayed</b>	<ol style="list-style-type: none"> <li>1. Power supply not connected properly</li> <li>2. Camera cable not properly connected</li> </ol>	<ol style="list-style-type: none"> <li>1. Reconnect the power cable securely</li> <li>2. Verify all camera and system connections and power on the device</li> </ol>
<b>Blurred image</b>	<ol style="list-style-type: none"> <li>1. Optical coupler not properly focused</li> <li>2. Endoscope or coupler is contaminated</li> </ol>	<ol style="list-style-type: none"> <li>1. Adjust the focal length of the optical coupler</li> <li>2. Clean the endoscope and coupler with appropriate materials</li> </ol>
<b>Incorrect / abnormal color</b>	<ol style="list-style-type: none"> <li>1. White balance (WB) not set correctly</li> <li>2. Improper WB procedure</li> </ol>	<ol style="list-style-type: none"> <li>1. Set the camera to the correct WB mode</li> <li>2. Re-perform white balance using a clean, neutral (white) surface. Ensure no contaminants (e.g., iodine) are present. The display should show a fully white image during calibration. Perform adjustment for approximately <b>2–3 seconds</b></li> </ol>
<b>Power indicator light off</b>	Power supply issue or blown fuse	Check power connection and replace fuse if necessary
<b>Excessive glare / reflection (speckle)</b>	Light source intensity too high	Reduce the light source intensity

## Chapter 8 – Care and Maintenance

### 8.1 Environmental Requirements

- Verify the power supply regularly. Do not operate the equipment if the voltage is outside the specified range (**AC 198V–242V**). Use a regulated power supply if necessary.
- Ensure the power supply is properly grounded to improve safety and reduce electromagnetic interference.
- Do not operate or store the equipment in humid, dusty, or corrosive environments. Avoid exposure to corrosive gases or liquids.
- Inspect the power cord regularly. If damage or wear is detected, replace it immediately.
- Before cleaning or disinfecting the external surfaces (camera, fiber optic cable), disconnect the power supply. Clean using a soft, lint-free cloth with medical alcohol. Do **not** use detergents or chemical disinfectants that may damage the equipment. *(Recommended maintenance frequency: once per month)*
- Do not open the device housing. Internal cleaning, disassembly, or repair must not be performed by the user.
- After transporting or relocating the equipment, verify that all connections are secure before use.
- In case of malfunction, contact qualified service personnel or the manufacturer.

### 8.2 Equipment Care and Handling

- Do not direct the camera toward intense light sources (e.g., surgical lights at maximum intensity, direct sunlight), as this may damage the imaging sensor.
- Operate the equipment within the specified temperature range of **5°C to 35°C**. Avoid extreme temperatures.
- Ensure the operating environment is clean, dry, and free from dust. Protect the equipment from moisture and mechanical shock.
- Maintain distance from strong radio frequency (RF) sources (e.g., communication equipment, high-power audio/video transmitters) to prevent interference.
- For disinfection of the camera and connected components, use **low-temperature plasma sterilization (if applicable)** or wipe with medical alcohol or iodophor. **Do not use high-temperature sterilization, autoclaving, or immersion methods**, as these may damage the device.
- The equipment contains no user-serviceable wear parts under normal operating conditions. Any required repairs must be performed by qualified personnel authorized by the manufacturer.

### 8.3 Transportation and Storage

- When not in use, cover the equipment with a dust cover or store it in appropriate packaging.
- Do not store the equipment in environments with high humidity or excessive dust.
- Perform routine maintenance to keep the equipment clean and in proper working condition.  
*(Recommended maintenance frequency: once per month)*
- Handle the equipment with care during transportation and storage. Protect it from vibration, impact, and exposure to rain or moisture.